



Dental-Instruments Germany



Implantology Instruments

Ref. 15-83

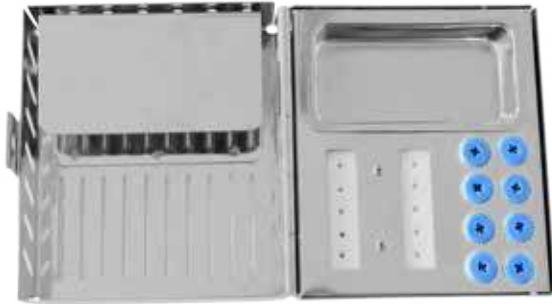

100,0 x 90,0 x 50,0 mm

Ref. 15-84



100,0 x 90,0 x 50,0 mm

Ref. 15-85

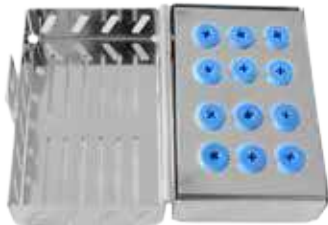

80,0 x 55,0 x 40,0 mm

Ref. 15-86

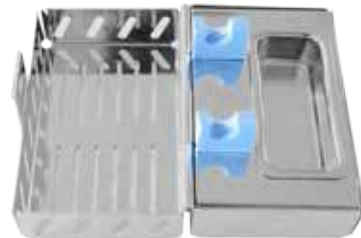

80,0 x 55,0 x 40,0 mm

Bohrerstände

Ref. 15-88



63,0 x 25,0 x 30,0 mm

Ref. 15-87

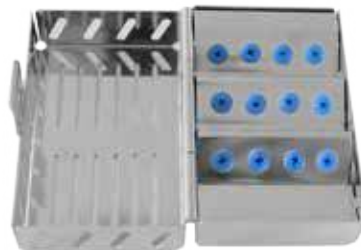

80,0 x 55,0 x 40,0 mm

Knochenmahlzange mit Titanzahnung

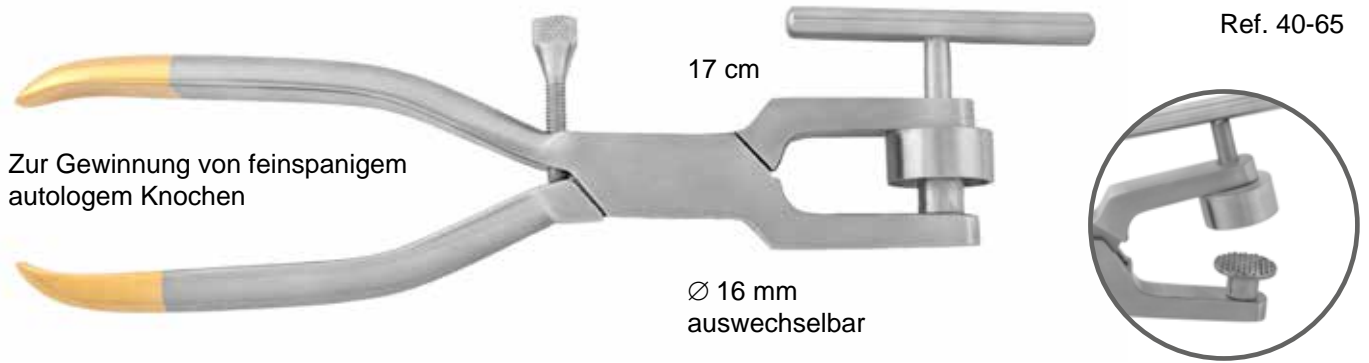

Hammer

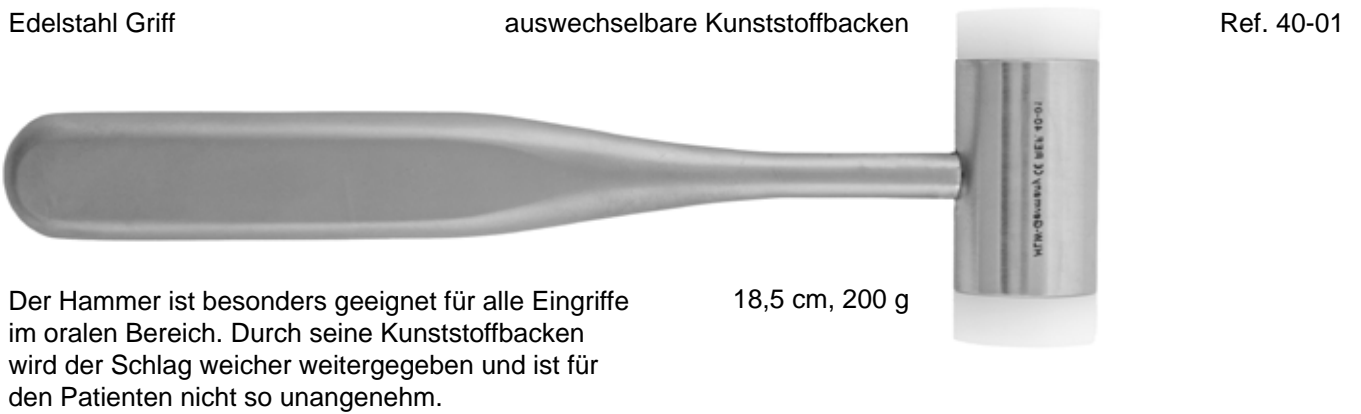

Knochen-Mischdose



Knochenspritze

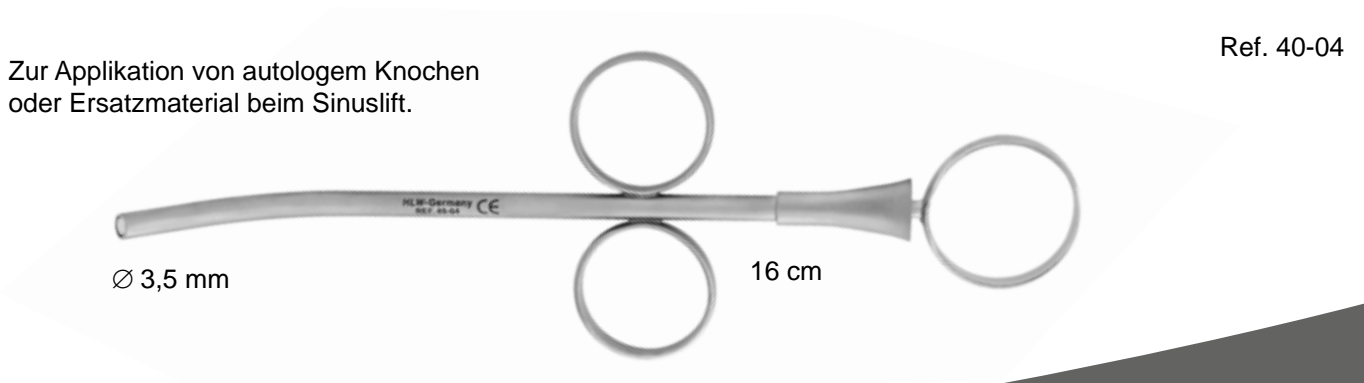

Bestell-Nr.
Order-No.

Medizinschale



Ø 30 mm

Ref. 40-51B



Ø 45 mm

Ref. 40-51A



Ø 60 mm

Ref. 40-51



Ø 80 mm

Ref. 40-51C

Stopfer & Schaufel zum Aufbringen von Knochenmaterial

Ref. 40-70



Stopfer & Schaufel zum Aufbringen von Knochenmaterial

Ref. 40-72



Stopfer & Löffel zum Aufbringen von Knochenmaterial

Ref. 40-71



Die Schaufeln und Löffel sind passend für die Knochenschaber Ref. 40-76 und 40-77 auf Seite 18.

Ø 10 mm extra leichte Deluxe
Hohlgriff Instrumente

Sinus Lift

H01 Ref. 40-06



H02 Ref. 40-07



K03 Ref. 40-08



K04 Ref. 40-09



K78 Ref. 40-10



K77 Ref. 40-11



Bestell-Nr.
Order-No.

Lift-Elevatoren

Ø 10 mm extra leichte Deluxe
Hohlgriff Instrumente

B01 Ref. 40-15



B02 Ref. 40-16



B03 Ref. 40-17



Elevatoren

Ø 10 mm extra leichte Deluxe
Hohlgriff Instrumente

E01 Ref. 40-12



E02 Ref. 40-13



E03 Ref. 40-14



Sinus-Elevatoren

Teller-Elevator mit Skalierung



Ref. 40-S001

Sinus-Elevator



Ref. 40-S002

Sinus-Elevator



Ref. 40-S003

Sinus-Elevator



Ref. 40-S004

Stopfer mit Skalierung



Ref. 40-S005

Bestell-Nr.
Order-No.

Zur atraumatischen Extraktion von Implantaten,
schont Weichgewebe und Knochen.

PT01 Ref. 26-60



PT02 Ref. 26-61



6 Einsätze Ref. 40-60

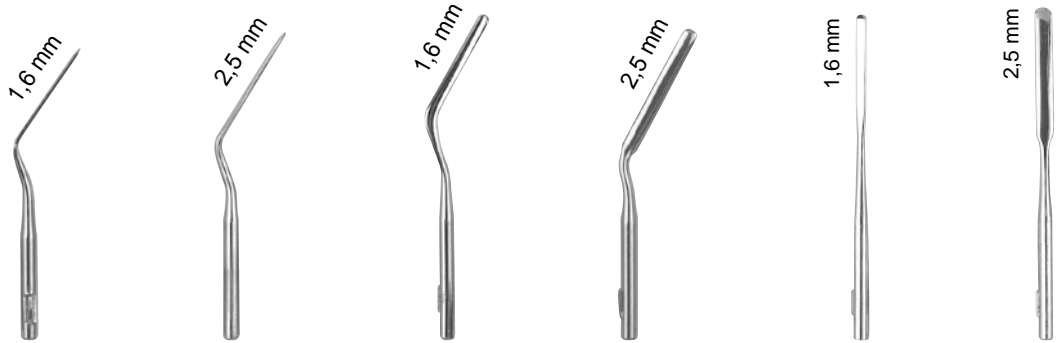

Haltegriff für Periotome

Ref. 40-59



Zahnsonden mit auswechselbaren Spitzen

Rundgriff hohl - hollow

Ref. 23-11

extra leicht



13,5 cm



Ref. 27-9E



Ref. 27-11E



Ref. 27-7E



Ref. 27-8E



Ref. 27-13E



Ref. 27-12E

Ø 10 mm extra leichte DELUXE Hohlgriff Instrumente

Micro Raspatorium / Meißel

Ref. 40-24

2,5 mm



2,5 mm

Micro Raspatorium / Meißel

Ref. 40-23

3,5 mm



3,5 mm

Prichard

Ref. 40-22

4,0 mm



Raspatorium und Abhalter in einem Instrument. Scharfes Raspatorium zur Präparation des Mucoperiostlappens und anderer Gewebestrukturen. Das flache Ende eignet sich perfekt zum Abhalten von Lappen, auf der lingualen Seite auch zum Schutz des Nervus Lingualis beim Einsatz von rotierenden Instrumenten. Durch seine Hochglanzpolitur auch als Spiegel verwendbar.

Dieses Arbeitsende gibt es auch skaliert, dann dient es zur perfekten Achskontrolle im Molarenbereich bei implantologischen Eingriffen.

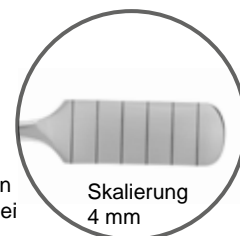

Ref. 40-22A

Zur perfekten Präparation des lingualen Mucoperiostlappens, durch seine Biegung passt sich das eine Arbeitsende den lingualen anatomischen Gegebenheiten an.

Lingualraspatorium

Ref. 40-20

2,8 mm



2,8 mm

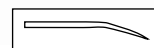

Molt - Raspatorium fein

Ref. 40-25

4,0 mm



3,0 mm

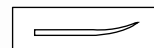

Freer - Raspatorium scharf/stumpf

Ref. 40-26

6,0 mm



5,0 mm

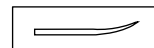

Bestell-Nr.
Order-No.

Ø 10 mm extra leichte DELUXE Hohlgriff Instrumente

Raspatorium

Ref. 40-18



Der Pfeil dient zur Feinpräparation von Papillen und zarten Gewebestrukturen bei Implantationen oder in der Parodontologie, das herzförmige Arbeitsende dient zur atraumatischen Präparation auf glatten Knochenstrukturen und wenn man die Spitze in den Knochen einsticht, als perfekter rutschsicherer Abhalter bei atraumatischen Feinsteingriffen.

Knochenschaber

Ref. 40-21



Zur optimalen Gewinnung von autologen Knochen bei der Implantation und bei parodontologischen Eingriffen. Das breite Ende kann ideal zur Kieferkammglättung vor der Implantation gebraucht werden und jederzeit zur zusätzlichen Gewinnung von Knochen im normalen OP - Gebiet. Schneidet ohne großen Kraftaufwand perfekte Knochenespäne. Zur Gewährleistung der optimalen Schärfe, empfehlen wir nach jeder Benutzung, das Abziehen mit einem Arkansas Stein.

Papillenelevator

Ref. 40-19



Zur atraumatischen Präparation von Papillen und Feinstrukturen bei der Implantation und ästhetischer Parodontologie.

Fixier-Instrument

Ref. 40-41



Für Pins und Membranen

Misch-Spatel

Ref. 40-42



Zum Mischen und Handling von großvolumigen Augmentationen.

Ergo-Mundspiegel Rhodium



Ø 22,0 mm

Ref. 23-35

NEW!

Long-Mundspiegel Rhodium



18,0 x 33,0 mm

Ref. 23-38

NEW!

Parallelometer Rhodium



13,5 cm

Ref. 23-39

NEW!

Doppelseitiger Mundspiegel Rhodium, plan



Rückseite



Ø 24,0 mm

double side mirror

Ref. 23-40

NEW!

Spiegelgriffe

Fingerform hohl



Ref. 23-7

extra leicht

13,5 cm

Rundgriff hohl



Ref. 23-11

extra leicht

13,5 cm

Bestell-Nr.
Order-No.

Gewebezange / Knochensplitterzange

Ref. 14-10

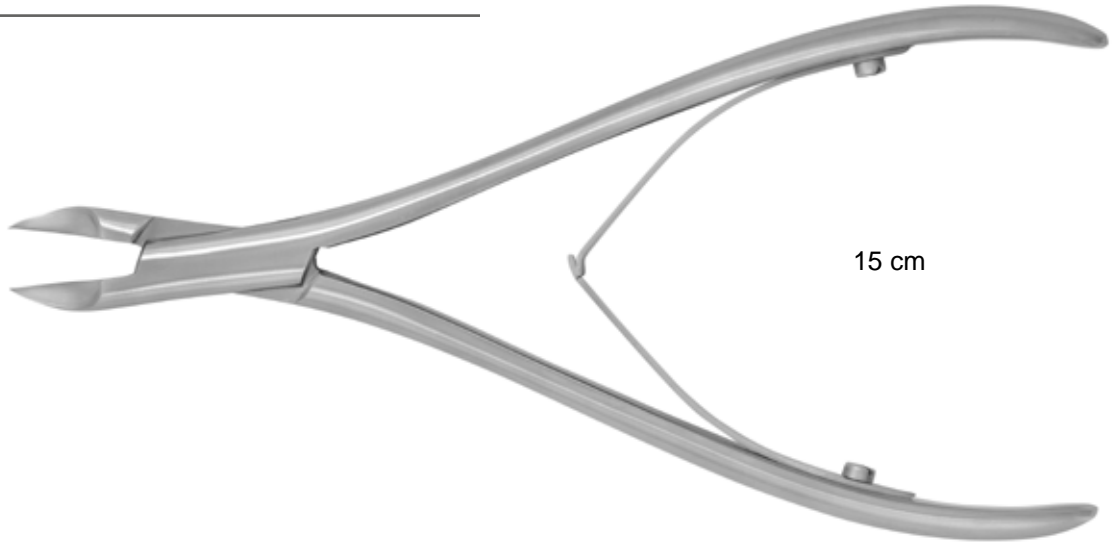

Hautstanzen

Ref. 40-52 Ø 3 mm 10 cm

Ref. 40-54 Ø 4 mm 10 cm

Ref. 40-56 Ø 5 mm 10 cm



Ref. 40-53 Ø 3 mm 10 cm

Ref. 40-55 Ø 4 mm 10 cm

Ref. 40-57 Ø 5 mm 10 cm



Rundskalpellgriff gebogen



Ref. 30-12A

Rundskalpellgriff-ERGOFORM



Ref. 40-27

Dieser Skalpellgriff liegt durch seine Form sicher und ergonomisch in der Hand, selbst bei längeren Eingriffen weniger Ermüdungserscheinungen in den Fingern.

Anwendungsbereich: 3,5 cm

Rundskalpellgriff-ERGOFORM



Ref. 40-27A

Anwendungsbereich: 2,5 cm

Skalpellgriff mit Skalierung



Ref. 30-9A

Skalpellgriff für Microskalpellklingen



Ref. 40-28

Microskalpellgriff

Micro Skalpellklingen auf Anfrage.

Bestell-Nr.
Order-No.

nach LANGENBECK

Ref. 15-17A



30 x 16 mm

21 cm

nach LANGENBECK

Ref. 15-17C

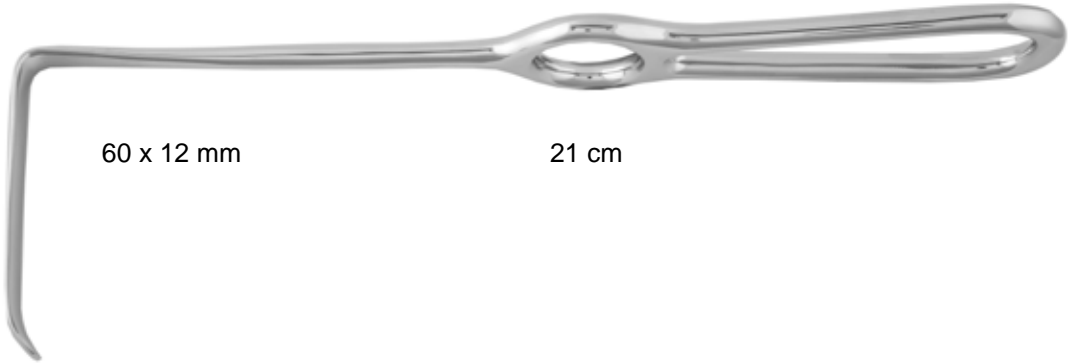

60 x 12 mm

21 cm

nach MIDDELDORF

Ref. 15-18



21 cm

nach MINNESOTA

Ref. 15-23



16 cm

Chirurgische Absaugkanülen

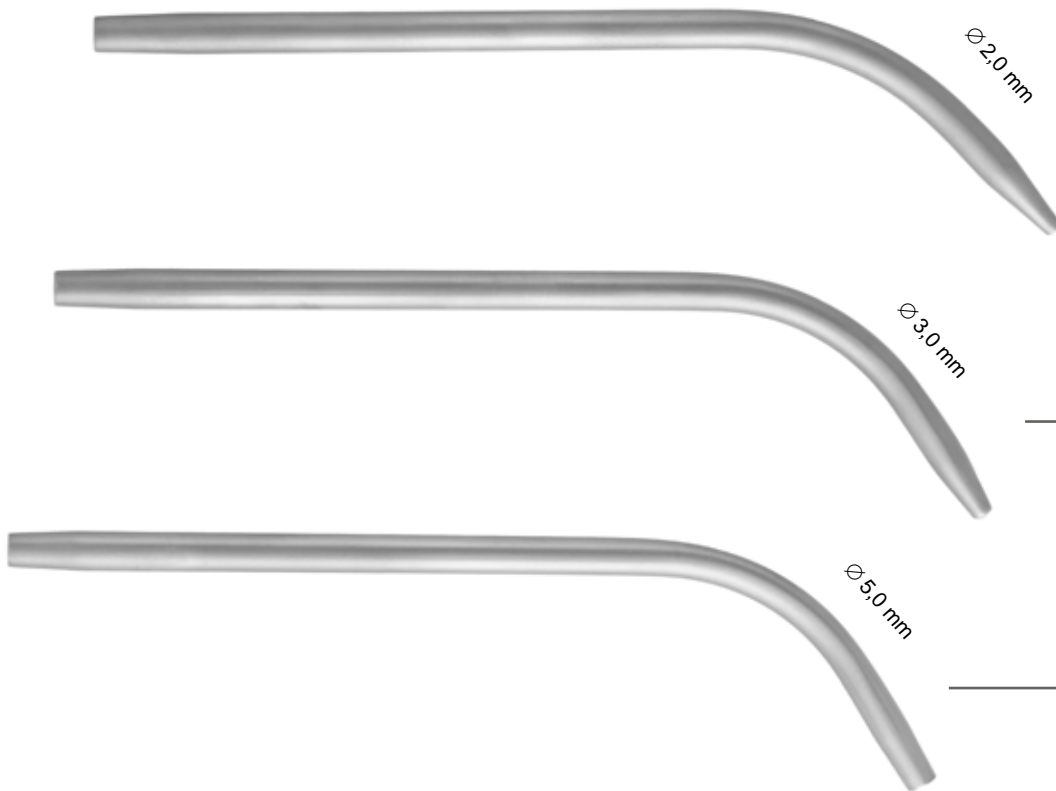

Ref. 40-48

Ref. 40-49

Ref. 40-50

Reinigungsbürsten für Absaugkanülen

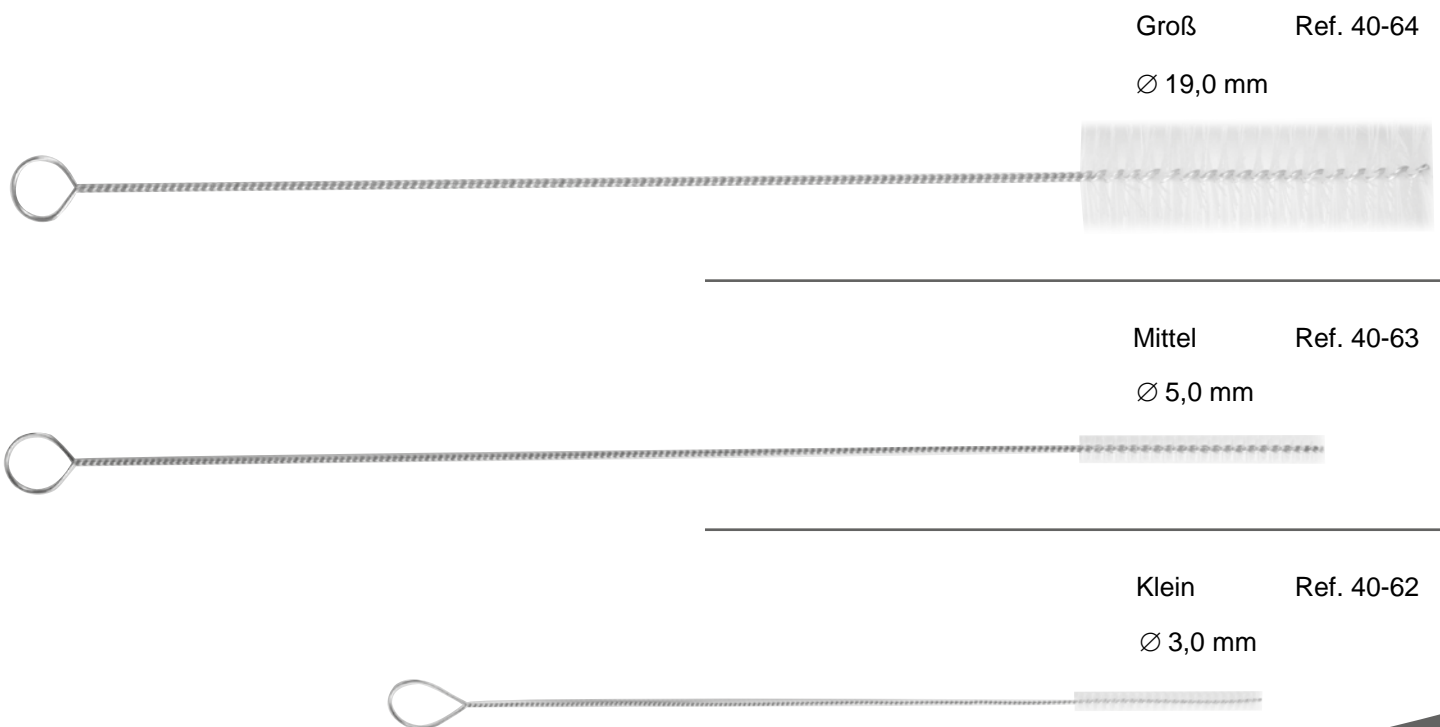

Bestell-Nr.
Order-No.

Knochenfalle / Absaugkanüle

Ref. 40-58



Ø 3,5 mm

für Knochenspähe

Ersatzfilter

Ref. 40-58A



Silikonfilter (sterilisierbar)
10er Pack

Wangenabhalter mit Absaugung

Ref. 40-500

NEW!



Wangenhalter

Bestell-Nr.
Order-No.

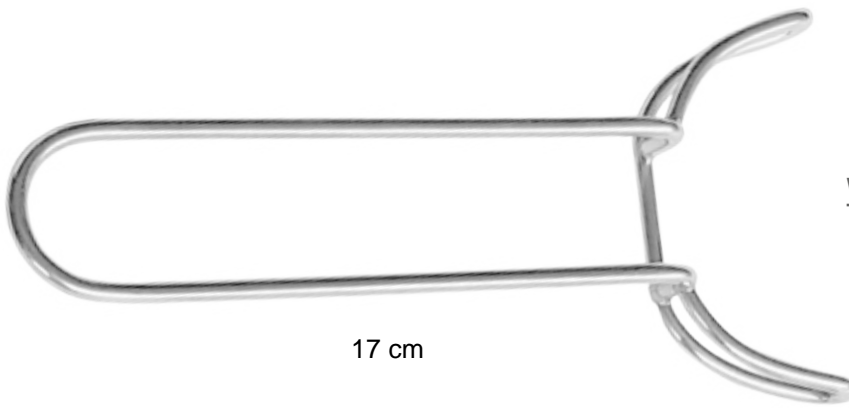

17 cm

Wangenhalter Vestibulum

Ref. 40-02

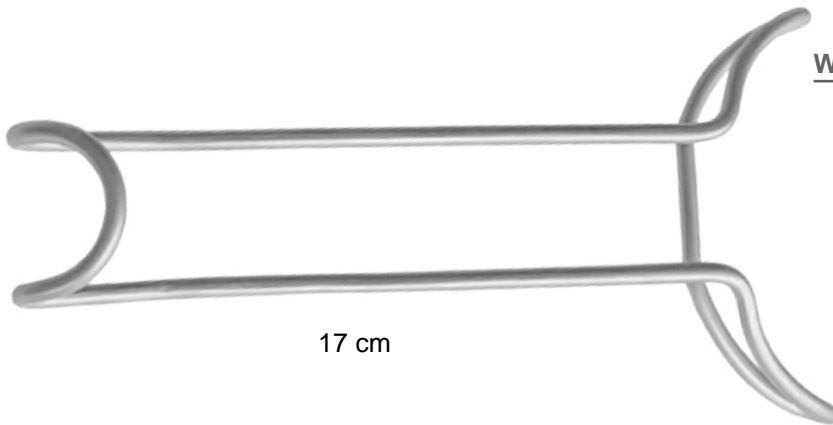

17 cm

Wangenhalter Vestibulum

Ref. 40-02A

NEW!

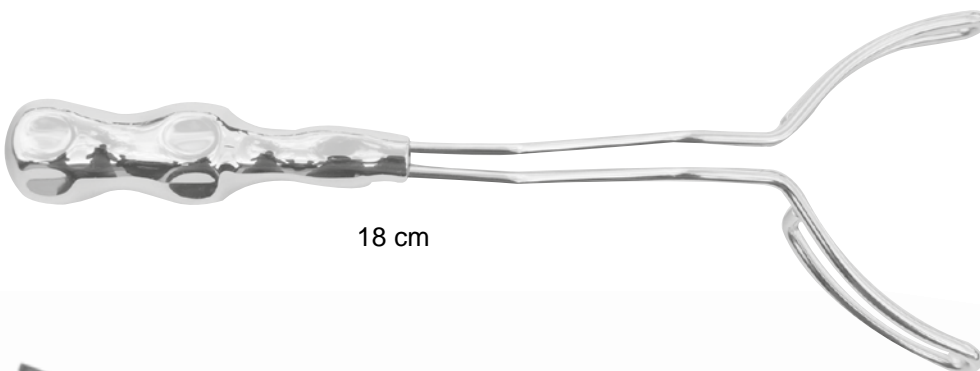

18 cm

Wangenhalter

Ref. 15-1

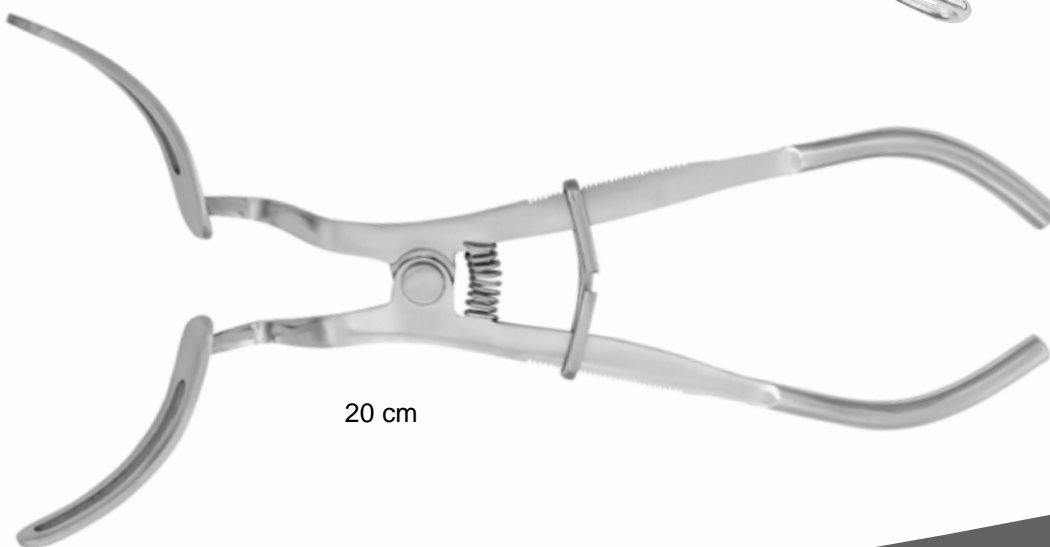

20 cm

Ivory

Ref. 15-4B



Bestell-Nr.
Order-No.

Knochenfeile

Schluger

Ref. 26-65

Hohlgriff Ø 10 mm extra leicht



Hirschfeld Paradontalfeilen

Hirschfeld 3/7

Ref. 40-66



Hirschfeld 5/11

Ref. 40-67



Knochenschaber

Zur Gewinnung von feinspanigem autologem Knochen

Ref. 40-76

gerade



Ref. 40-76A

Ersatzklinge



Ref. 40-77

gebogen

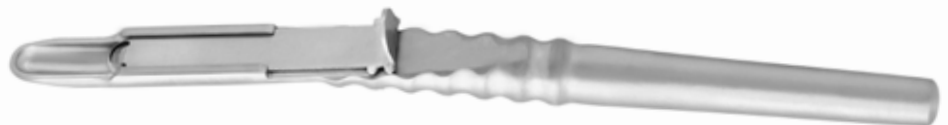

Ref. 40-77A

Ersatzklinge



Ref. 40-30



gerade,
17,5 cm

Ref. 40-31



gebogen,
17,5 cm

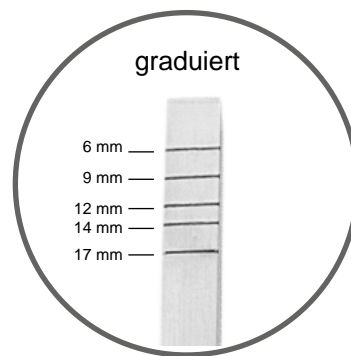

Ref. 40-32



gerade,
17,5 cm

Ref. 40-33



gebogen,
17,5 cm

Bestell-Nr.
Order-No.

P.A. Meißel

Ochsenbein Fig. 1

Ref. 26-25



16,5 cm

Ochsenbein Fig. 2

Ref. 26-26



16,5 cm

P.A. Micro Meißel

Fedi 1

Ref. 40-68



17,5 cm

Fedi 2

Ref. 40-69



17,5 cm

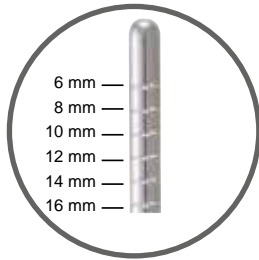

Osteotome konvex

zum Kondensieren des Implantatlagers bei weichem Knochen.



Ø 2,8 mm Ref. 40-34



Ø 3,1 mm Ref. 40-35



Ø 3,5 mm Ref. 40-36



Ø 3,8 mm Ref. 40-37

Osteotome mit Stop bajonett

zum Kondensieren des Implantatlagers bei weichem Knochen und für den internen Sinuslift nach Summers. Durch den Stopp maximale Sicherheit bei der Kondensation im Unterkiefer über dem Nervus Mandibularis und beim Sinuslift nach Summers.



Ø 3,0 mm Ref. 40-38



Ø 3,3 mm Ref. 40-39



Ø 4,0 mm Ref. 40-40

Bestell-Nr.
Order-No.

Osteotome konkav

zum Kondensieren des Implantatlagers bei weichem Knochen

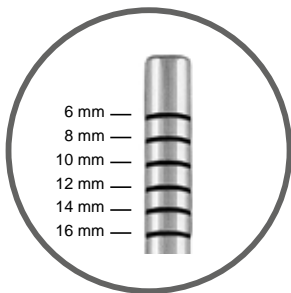

Ref. 40-80 Ø 2,8 mm



Ref. 40-81 Ø 3,1 mm



Ref. 40-82 Ø 3,5 mm



Ref. 40-83 Ø 3,8 mm





Implantatpinzette

Dieses Instrument ist die optimale Hilfe zum Gebrauch von allen Micro-Schraubensystemen in der Implantologie.

Es fasst die Schraubenzieher perfekt und ermöglicht punktgenaues platzieren der Schrauben auch weit im Molarenbereich. Für alle gängigen Systeme.

Ref. 40-43



Ø 1,3 mm
Ø 1,9 mm

Ref. 40-43A



Zur interoralen Platzierung von Abutments.

Ø 3,0 mm

Haltepinzette TITAN

mit Schloss

Ref. 40-43B



16 cm

Bestell-Nr.
Order-No.

Knochenmühle

Ref. 40-92

NEW!



Wundspreizer

Ref. 15-28

7 cm



Ref. 15-29

Backen
gezahnt

4,5 cm

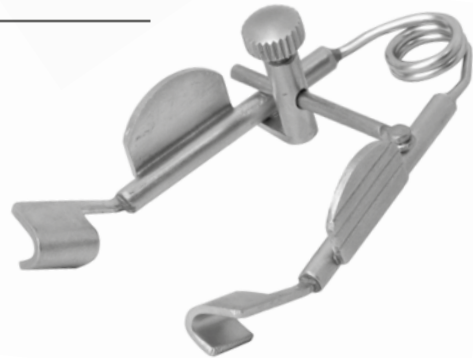

Messzange (Osteometer)

Zur Messung von Kieferkambreiten

Ref. 40-75

0-25 mm

15 cm

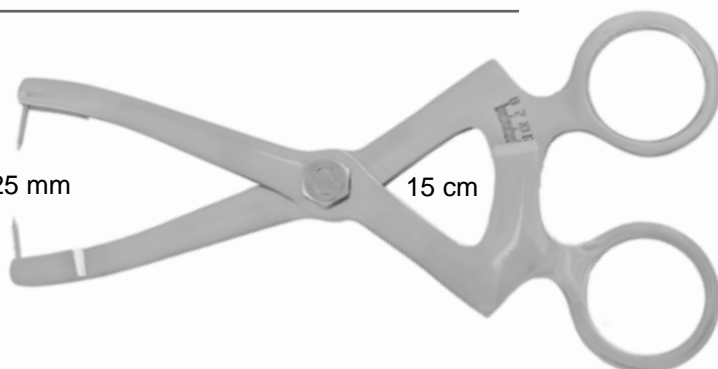

Messzirkel

Dient zum Abgreifen aller notwendigen Maße bei der Implantation und allen prothetischen Planungen und Arbeiten.

Durch seine 75° Abwinkelung ideal für die orale Anwendung.

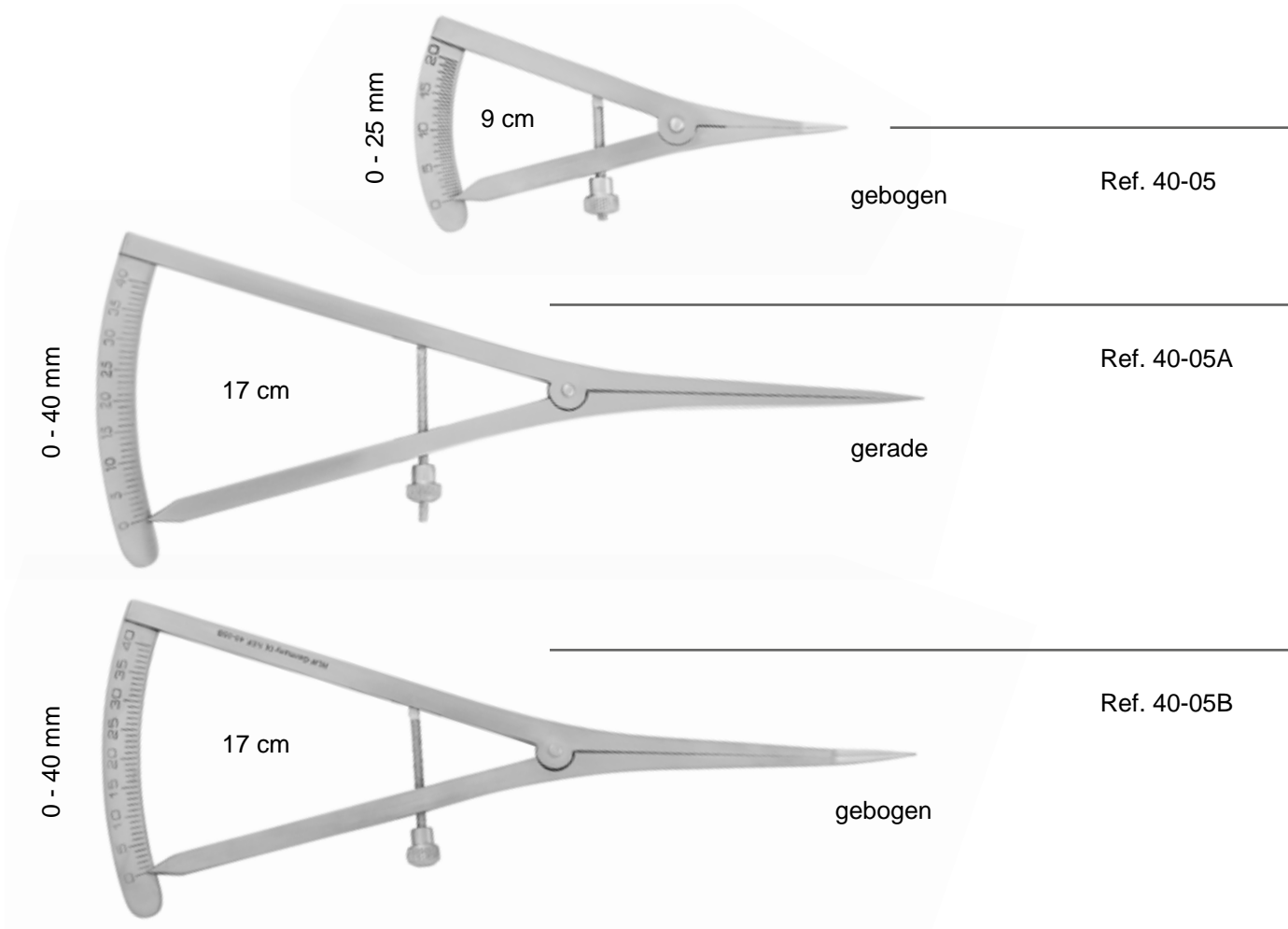

gebogen

Ref. 40-05

gerade

Ref. 40-05A

gebogen

Ref. 40-05B

Messlineal



Ref. 40-05C

NEW!

Messlehre nach Krekeler



Ref. 40-05D

NEW!



Bestell-Nr.
Order-No.

Micro- Anat.-Pinzette

Ref. 40-44A

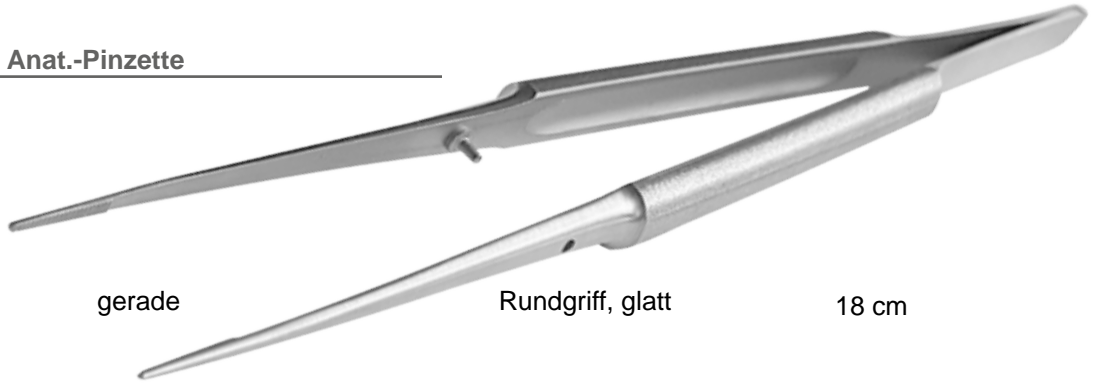

gerade

Rundgriff, glatt

18 cm

Micro- Anat.-Pinzette

Ref. 40-45A

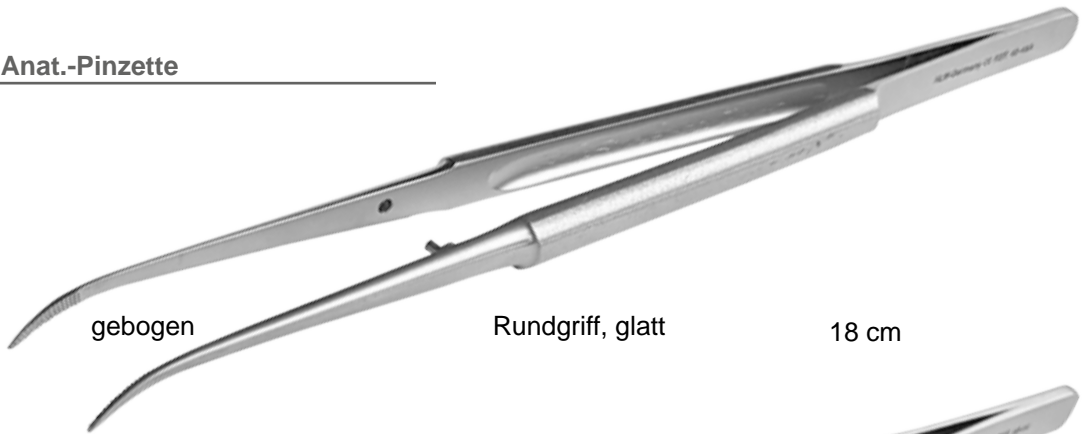

gebogen

Rundgriff, glatt

18 cm

Micro- Chir.-Pinzette

Ref. 40-44

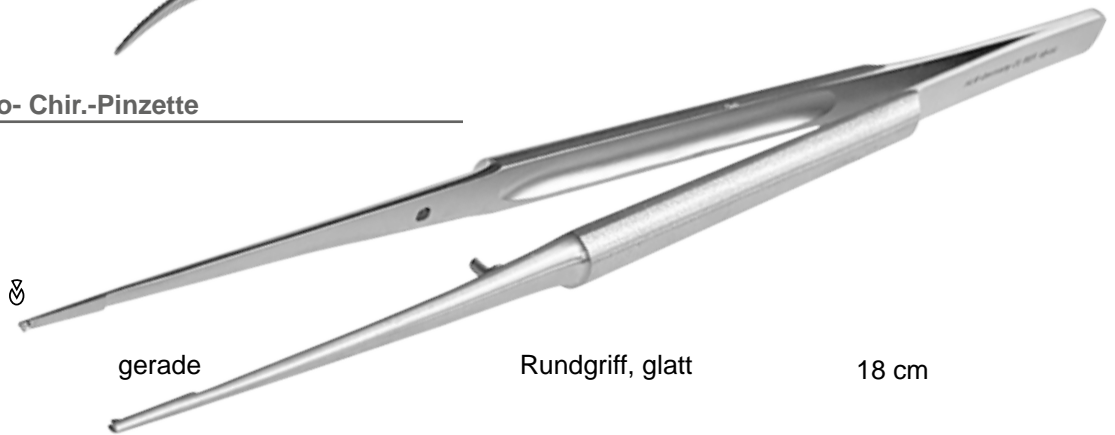

gerade

Rundgriff, glatt

18 cm

Micro- Chir.-Pinzette

Ref. 40-45

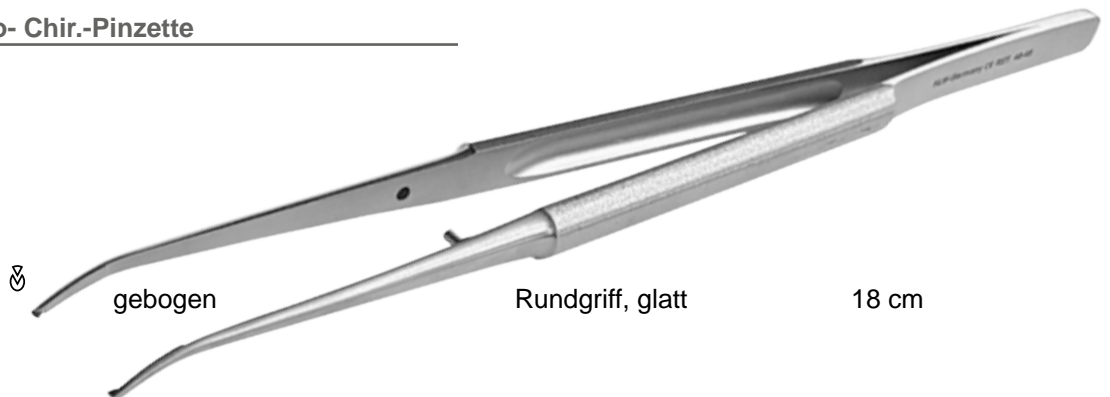

gebogen

Rundgriff, glatt

18 cm

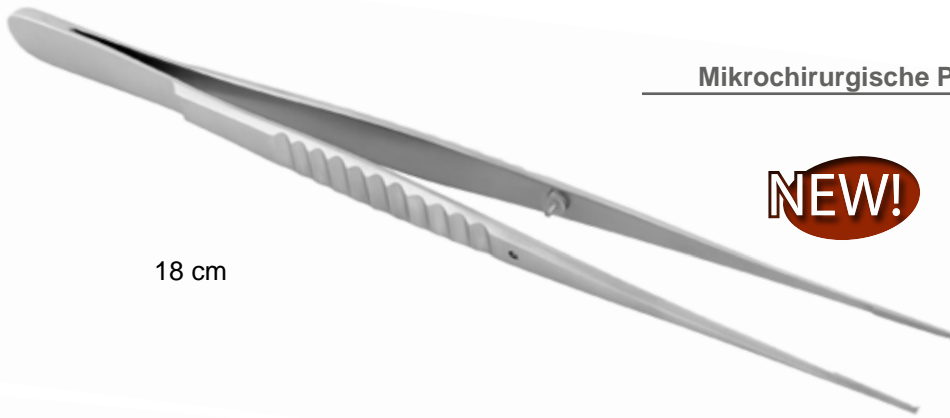

18 cm

Mikrochirurgische Pinzette gerade

NEW!

Ref. 22-41

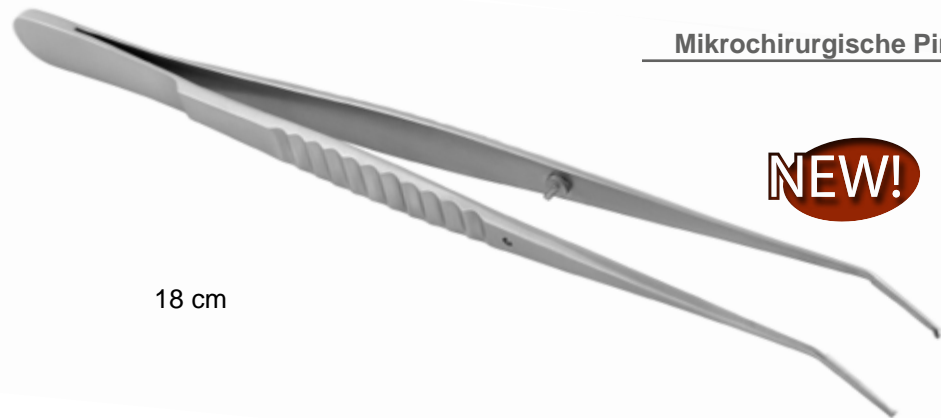
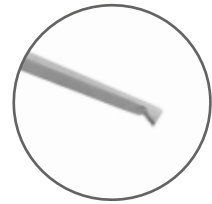

18 cm

Mikrochirurgische Pinzette gebogen

NEW!

Ref. 22-42

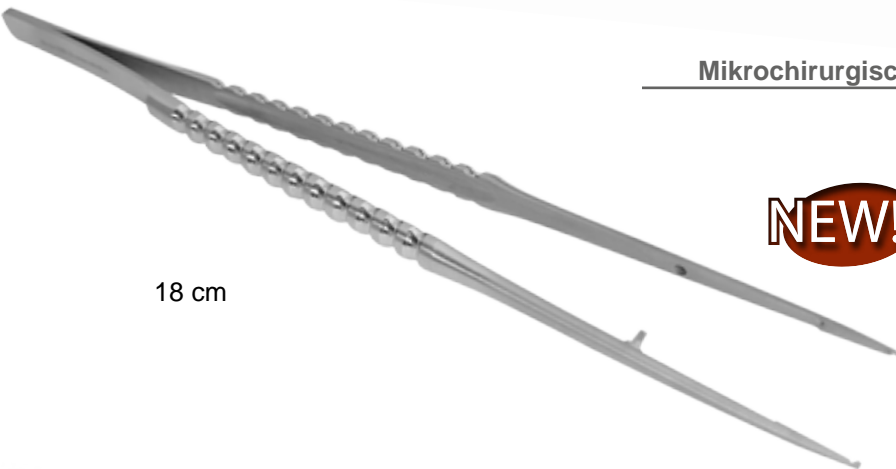
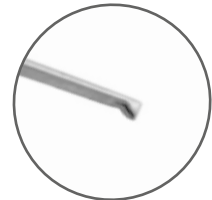

18 cm

Mikrochirurgische Pinzette gerade

NEW!

Ref. 40-97

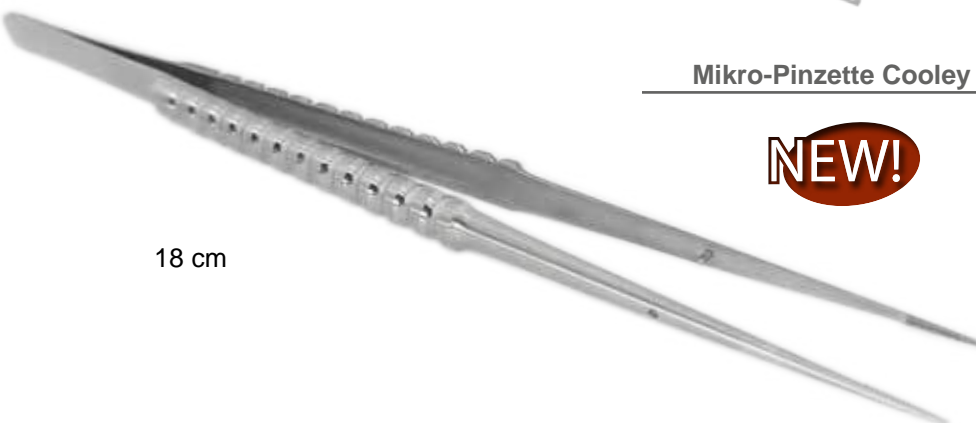
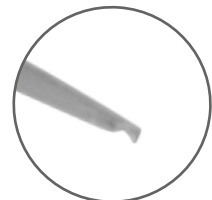

18 cm

Mikro-Pinzette Cooley gerade

NEW!

Ref. 40-98



Bestell-Nr.
Order-No.

Mikro-Nadelhalter TC gerade

Ref. 40-95TC



gerade
straight

NEW!



18,0 cm

Mikro-Nadelhalter TC gebogen

Ref. 40-96TC

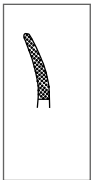

gebogen
curved

NEW!



18,0 cm

Mikro-Nadelhalter gebogen

Ref. 40-46

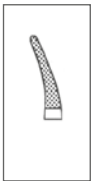

gebogen
curved

TC
Hartmetall

Rundgriff, glatt



18,0 cm

Mikro-Nadelhalter gerade

Ref. 40-47



gerade
straight

TC
Hartmetall

Rundgriff, glatt

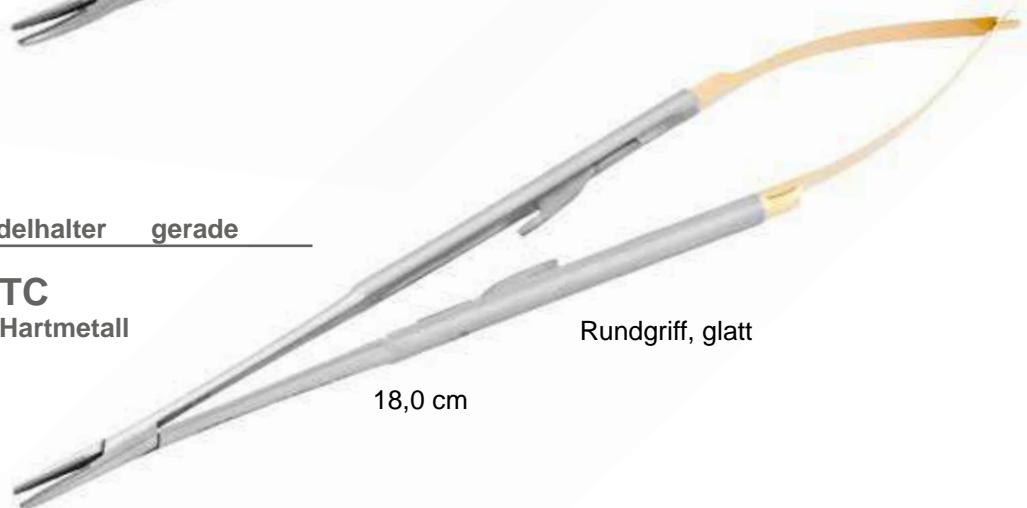

18,0 cm



18,0 cm

Mikro-Nadelhalter diamantiert gerade



gerade
straight

Ref. 40-95D

NEW!

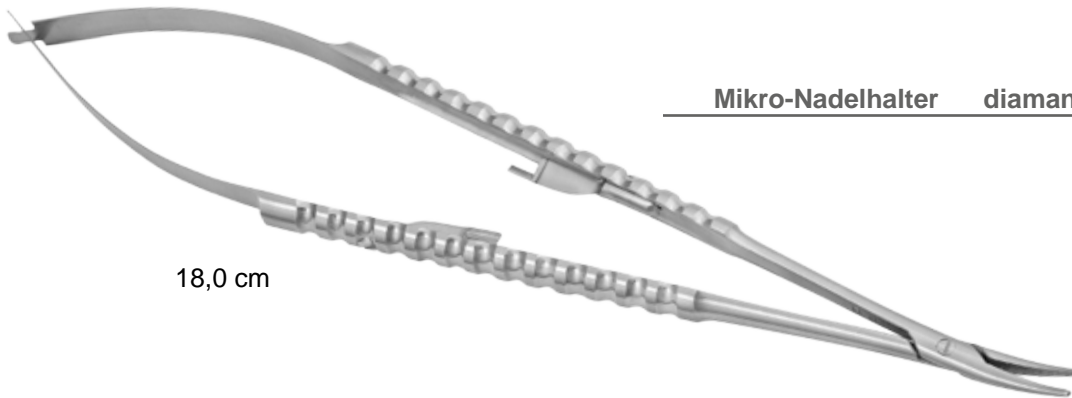

18,0 cm

Mikro-Nadelhalter diamantiert gebogen

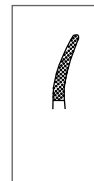

gebogen
curved

Ref. 40-96D

NEW!

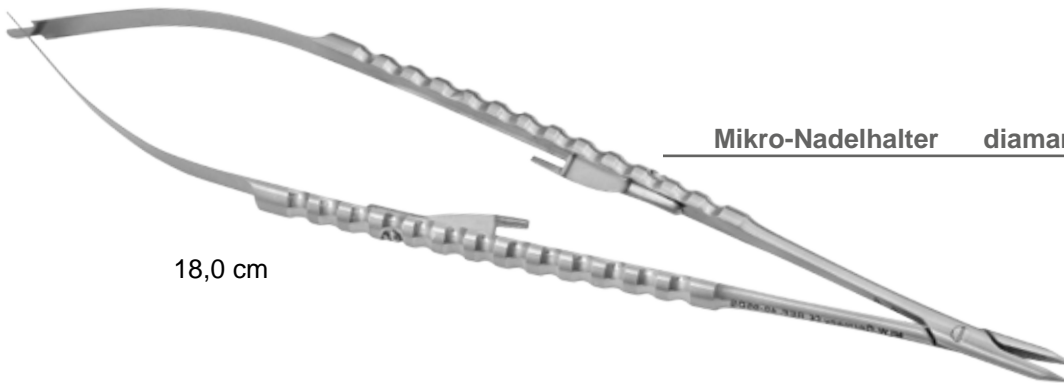

18,0 cm

Mikro-Nadelhalter diamantiert spitz, gerade



gerade
straight

Ref. 40-95DS

NEW!

diamantiert
spitz

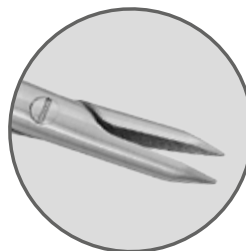

Bestell-Nr.
Order-No.

Micro-Schere

Ref. 19-23B



gebogen
curved

TC
Hartmetall

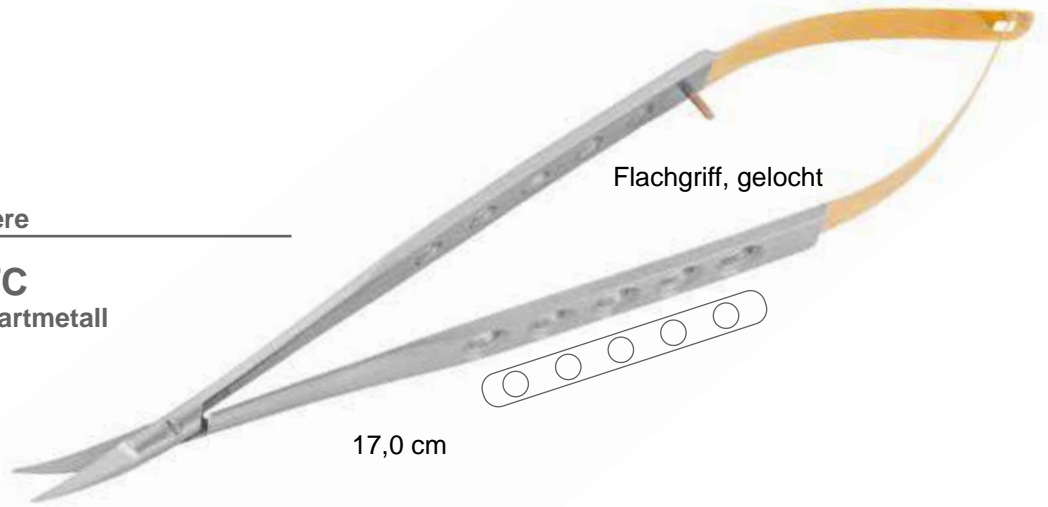

Micro-Schere

Ref. 40-48B



gebogen
curved

TC
Hartmetall

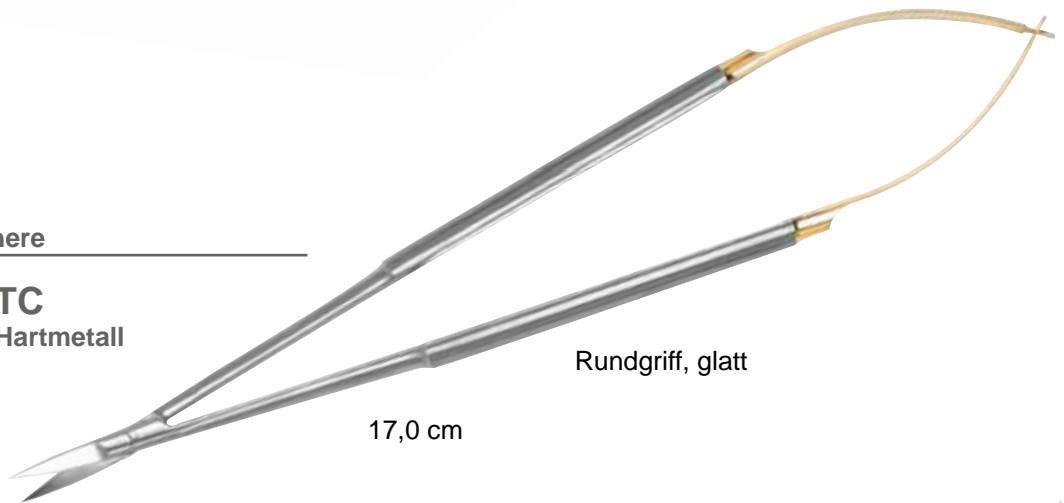

Micro-Schere

Ref. 40-48C

NEW!



gebogen
curved

TC
Hartmetall

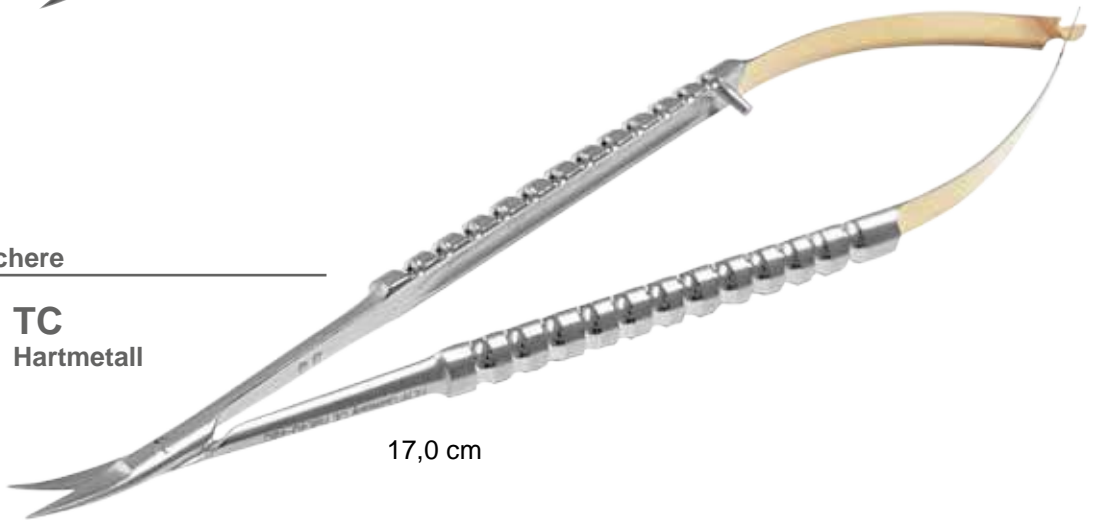

Tunnelierinstrument

Ref. 40-85

NEW!



Tunnelierinstrument

Ref. 40-86

NEW!



Tunnelierinstrument

Ref. 40-87

NEW!



PA-Messsonde

Ref. 27-22AB

NEW!





Daimlerstraße 19
D-92533 Wernberg-Köblitz

Phone: +49-9604-90991-0
Fax: +49-9604-90991-29

info@hlw-dental.com
www.hlw-dental.com